

Modular Cooking Range Line thermaline 85 - 4 Zone Electric Solid Top on Oven, 1 Side with Backsplash

ITEM # _____

MODEL # _____

NAME # _____

SIS # _____

AIA # _____



588694 (MBLLGBH8AO) Electric Solid Top, 4 zones, one-side operated, on Oven - H2

Short Form Specification

Item No.

Unit constructed according to DIN 18860_2 with 20 mm drop nose top. Internal frame for heavy duty sturdiness in stainless steel. 2 mm top in 1.4301 (AISI 304). Flat surface construction, wide rounded, easily cleanable. THERMODUL connection system enables seamless worktop when units are connected and avoids soil penetrating. Solid top made of smooth, pore-free, steel. 4 independently controlled heating zones with 2 electronic sensors per zone for temperature surface control and 8 power levels. Rapid plate heat up, continuously ready to use. Overheat protection switches off the supply in case of overheating. Standby function saves energy and quickly recovers maximum power. Metal knobs with embedded hygienic silicon "soft" grip enable easier handling and cleaning. Electric static oven base with 40 mm thick oven door and ribbed enamelled steel base plate. Oven chamber with 2 levels of runners for 2/1 GN shelves to enable simultaneous and faster cooking. Heavy duty thermostat with temperature range up to 350°C, electronic sensor for precise temperature control and manual humidity control in the cooking chamber. Upper heating element can also be used for grilling, with or without ventilating mode. Flat surface construction, easily cleanable. Overheat protection switches off the supply in case of overheating. Standby function saves energy and quickly recovers maximum power. Metal knobs and oven handles ergonomically designed with embedded hygienic silicon "soft" grip enable easier handling and cleaning. IPX5 water resistance certification.

Main Features

- Rapid heat up of the plate and continuously ready for use.
- Overheat protection: the temperature sensor switches off the supply in case of overheating.
- Pans can easily be moved from one area to another without lifting.
- Wide rounded cleaning zone around the plates for easier cleaning.
- All major components may be easily accessed from the front.
- THERMODUL connection system creates a seamless work top when units are connected to each other thus avoiding soil penetrating vital components and facilitating the removal of units in case of replacement or service.
- Metal knobs with embedded hygienic "soft-touch" grip for easier handling and cleaning. The special design of the controls prevents infiltration of liquids or soil into vital components.
- Cooking plate and base joint profile guarantee against soil infiltration.
- Two electronic sensors per zone to control surface temperature and to protect cooking plate from overheating.
- 8 power levels.
- 4 heating zones independently controlled.
- Solid top cooking surface made of 20 mm thick steel, DIN 1.7335, smooth pore-free and easy to clean.
- 40 mm thick oven door for heat insulation.
- Handles are ergonomically designed with silicon "soft" grip for easy handling and cleaning.
- Oven chamber to have 2 levels of runners to accommodate 2/1 GN trays and ribbed enamelled steel base plate.
- The upper heating element of the oven can also be used for grilling.
- Manual control of humidity in cooking chamber.
- Electronic sensor for precise temperature control.
- Oven temperature up to 300 °C

Construction

- 2 mm top in 1.4301 (AISI 304).
- Flat surface construction with minimal hidden areas to easily clean all surfaces
- Unit constructed according to DIN 18860_2 with 20 mm drop nose top.
- IPX5 water resistance certification.
- Internal frame for heavy duty sturdiness in stainless steel.

Sustainability

- Standby function for energy saving and fast recovery of maximum power.

Included Accessories

- 1 of Grid, chromium plated, for ovens 2/1 GN PNC 910652

APPROVAL: _____

Front

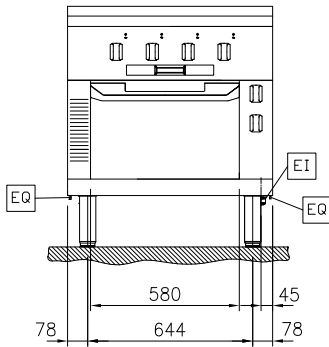

Side

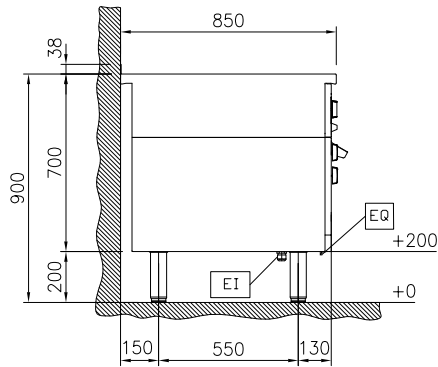

EI = Electrical inlet (power)
 EQ = Equipotential screw

Top

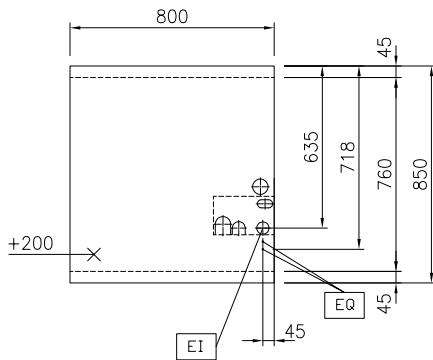



Electrolux
PROFESSIONAL

Modular Cooking Range Line thermaline 85 - 4 Zone Electric Solid Top on Oven, 1 Side with Backsplash

Electric

Supply voltage: 400 V/3N ph/50/60 Hz
Electrical power, max: 17.3 kW

Key Information:

Working Temperature MIN: 100 °C
Working Temperature MAX: 450 °C
External dimensions, Width: 800 mm
External dimensions, Depth: 850 mm
External dimensions, Height: 700 mm
Net weight: 223 kg
Configuration: On Oven; One-Side Operated
Front Plates Power: 3 - 3 kW
Back Plates Power: 3 - 3 kW
Solid top usable surface (width): 670 mm
Solid top usable surface (depth): 650 mm

Sustainability

Current consumption: 31.7 Amps



Modular Cooking Range Line
thermaline 85 - 4 Zone Electric Solid Top on Oven, 1 Side with
Backsplash
The company reserves the right to make modifications to the products
without prior notice. All information correct at time of printing.

2026.05.27